

Exidor 200/300 series

Bolts and latches range



Contents

- 02 Choose your finish
- 03 Product selector
- 06 Single door range
- 10 Rebated double door range
- 11 Non-rebated double door range
- 12 Outside access devices
- 15 Accessories
- 16 Keep options
- 22 Technical data
- 23 Parts list
- 24 Regulations
- 25 Glossary
- 26 Product features

Guarantee

To support the high quality and first class engineering that has gone into our Exidor range, we provide a ten year guarantee (subject to conditions) against defects due to faulty manufacturing, workmanship or defective material. We agree to replace any defective Exidor product free of charge provided the product has been fitted in accordance with the fitting instructions and maintained correctly.

Technical support

We're here to help with technical support.

Tel: 0845 223 2124
email: csdcomm@assaabloy.com

uniononline.co.uk

DOOR

Exidor 200/300 series bolts and latches

We are a leading manufacturer of panic and emergency exit hardware and joined the Union family in 2021. The Exidor range of products has been meeting the needs of architects, specifiers, project managers, OEMs and building managers for more than 90 years. And, we're proud to have built an unrivalled record of developing and continually enhancing a product range that's known and used all over the world.

The Exidor 200/300 series panic and emergency hardware offers a modern, aesthetically pleasing style giving optimum safety and security, carries the certifire quality mark, is fire rated and is certified to the European standards to ensure peace of mind.

Our market leading 200 range offers tried and tested quality and is available in a choice of fixed or adjustable bolts.

The 300 range offers all the benefits of the 200 series, but with the technology and convenience of either vertical or horizontal Pullman latches for smoother and quieter operation. The 300 series is also available as a mortice actuator for use with a cylinder mortice night latch.

EN 179:
For offices, factories and other environments where people are familiar with exit routes.

EN 1125:
For areas of entertainment, public buildings and other commercial applications.

Certified to 200,000 uses, the 200 and 300 series are available in latch or bolt versions, and accessories include a choice of outside access devices, dogging device, steel door fixing pack and a choice of keeps for different door materials and applications.



What does British manufacturing mean to us?

We make our products at our state-of-the-art manufacturing centre in the UK. This means we're close to our products and can ensure the quality and reliability of our product range – giving you the confidence and trust for total peace of mind.

We're proud that our products carry the Made In Britain mark.

Choose your finish



Exidor use epoxy powder coating for all painted surfaces to give a quality finish to our products, and offer silver, black or white as standard colours for the Exidor 200 and 300 series.

There is also a range of popular RAL and Hewi colours to match other ironmongery products that may be fitted. Brass and stainless steel finishes are also available but are not recommended for outside access devices, external use or use in corrosive environments. When ordering, please suffix the product code with the RAL or Hewi number.



A choice of finishes

All exit devices and outside access devices are available in a wide range of finishes:















Standard finishes:

-  Silver (RAL 9022)
-  Black
-  White

Plated finishes available:

-  Stainless steel effect
-  Brass effect

Popular RAL colours available:

-  Pure white 9010
-  Agate grey 7038
-  Olive brown 8008
-  Ultra marine blue 5002
-  Mint green 6029
-  Black green 6012
-  Ruby red 3003
-  Ivory 1014
-  Black red 3007
-  Traffic yellow 1023
-  Jet black 9005
-  Steel blue 5011
-  Fir green 6009
-  Anthracite grey 7016
-  Gold



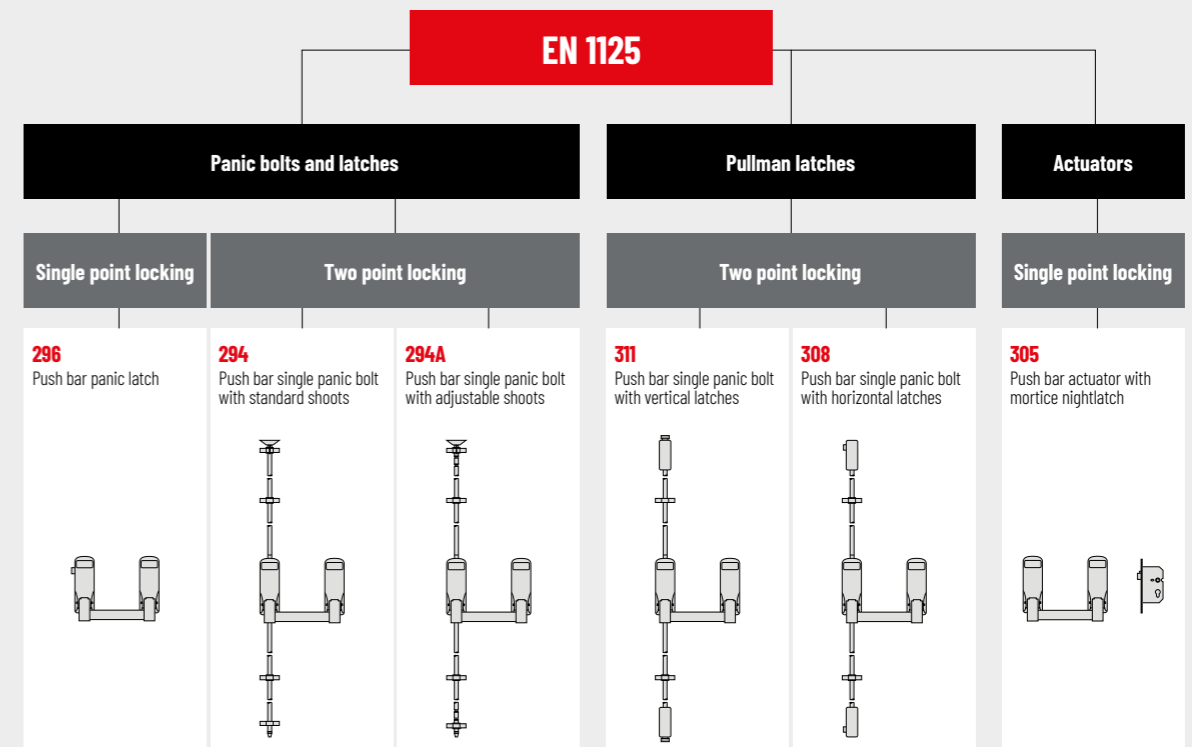
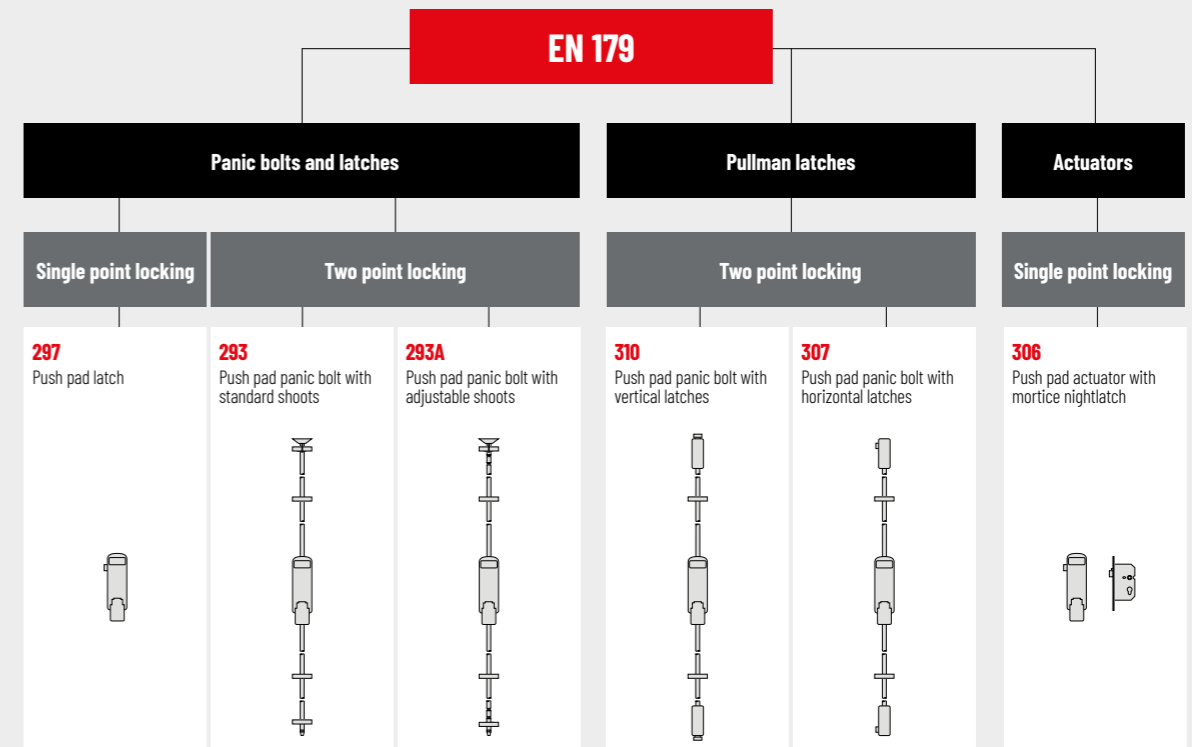

Single doors

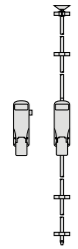
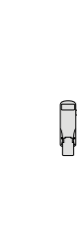
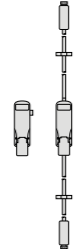
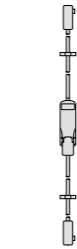
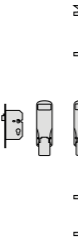

Rebated double doors

EN 179

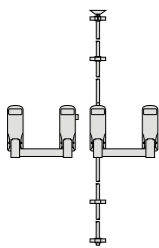
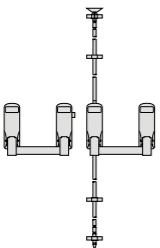
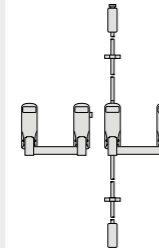
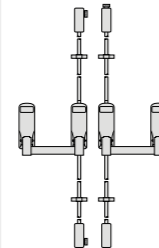
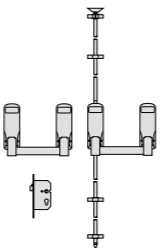
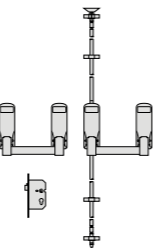
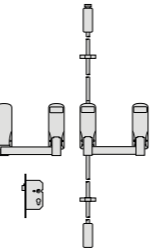

Panic bolts and latches		Pullman latches		Actuators		
Three point locking		Three point locking	Four point locking	Three point locking		
293, 297, 300 Push pad with standard shoots and latch 	293A, 297, 300 Push pad with adjustable shoots and latch 	297, 310, 300 Push pad with vertical latches and latch 	307, 310, 407, 407 Push pad with vertical and horizontal latches 	306, 293, rebate kit Mortice actuator with push pad bolt with standard shoots 	306, 293A, rebate kit Mortice actuator with push pad bolt with adjustable shoots 	306, 310, rebate kit Mortice actuator with push pad vertical pullman latches 

EN 1125

Panic bolts and latches		Pullman latches		Actuators		
Three point locking		Three point locking	Four point locking	Three point locking		
285 Push bar with standard shoots and latch (294 + 296 + 300) 	285A Push bar with adjustable shoots and latch (294A + 296 + 300) 	317 Push bar with vertical latches and latch (296 + 311 + 300) 	309 Push bar with vertical and horizontal latches (308 + 311 + 407 + 407) 	305, 294, rebate kit Mortice actuator with push bar standard shoot bolts 	305, 294A, rebate kit Mortice actuator with push bar adjustable shoot bolts 	305, 311, Rebate kit Mortice actuator with push bar vertical pullman latches 

Non-rebated double doors

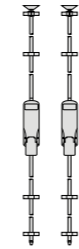
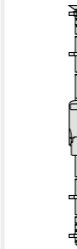
EN 179

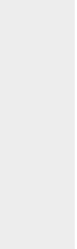
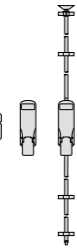
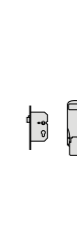
Panic bolts and latches		Pullman latches	Actuators		
Four point locking		Four point locking	Three point locking		
293, 293 Push pad with standard shoots 	293A, 293A Push pad with adjustable shoots 	310, 310 Push pad with vertical latches 	306, 293 Mortice actuator with push pad standard shoots 	306, 293A Mortice actuator with push pad adjustable shoots 	306, 310 Mortice actuator with push pad vertical pullman latches 

EN 1125

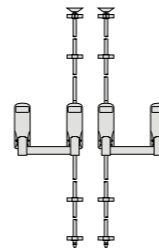
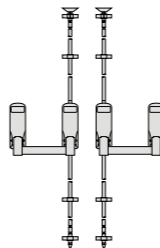
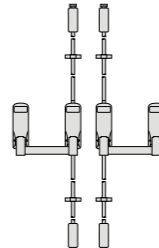
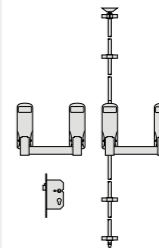
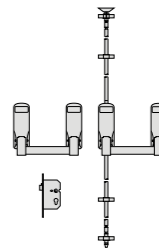
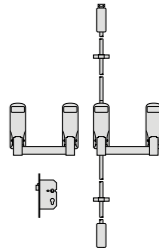
Panic bolts and latches		Pullman latches	Actuators		
Four point locking		Four point locking	Three point locking		
284 Push bar with standard shoots (294 + 294) 	284A Push bar with adjustable shoots (294A + 294A) 	316 Push bar with vertical latches (311 + 311) 	305, 294 Mortice actuator with push bar standard shoots 	305, 294A Mortice actuator with push bar adjustable shoots 	305, 311 Mortice actuator with push bar vertical pullman latches 



Single doors 297 / 306

Single point locking

297 Push pad panic latch

The Exidor 297 is a surface mounted rim latch for single and double door applications. Simply depressing the pad provides safe and speedy exit in the event of an emergency, whilst maintaining security against intrusion. An adapter for use with a rim cylinder for outside access is supplied as standard.

Classification No.	3	7	6	B	1	3	4	2	B	A
EN 179 : 2008										

- Non-handed
- Fire rated for use on timber and steel doors
- Surface mounted
- Adapter for operating with a rim cylinder

306 Push pad mortice actuator with cylinder mortice night latch

The Exidor 306 offers a push pad actuator unit with a cylinder mortice night latch case that can be supplied with or without a euro profile cylinder for access from the outside. A mortice plate is supplied as standard. The unit provides security on the outside with ease of escape from the inside in emergency situations.

Classification No.	3	7	6	0	1	3	4	2	B	A
EN 179 : 2008										

- Non-handed
- Surface mounted



Additional options

Exidor reversible panic latches can be supplied with:

- Steel door fixings
- suffix 'SD' after the product code

Optional accessories for the 297 panic latch

- 302EA outside access device with euro aperture - knob operated
- 302EC outside access device with euro cylinder - knob operated
- 3020A outside access device with oval aperture - knob operated
- 3020C outside access device with oval cylinder - knob operated
- 322EA outside access device with euro aperture - lever operated
- 322EC outside access device with euro cylinder - lever operated
- 325EA outside access device with euro aperture - lever operated
- 325EC outside access device with euro cylinder - lever operated
- 326EA outside access device with euro aperture - knob operated
- 326EC outside access device with euro cylinder - knob operated
- CL1 mechanical push button outside access device
- CL2 mechanical push button outside access device with passage facility
- CL3 quick code mechanical push button outside access device



Single doors 293 / 307 / 310

Two point locking

293 Push pad single panic bolt

The Exidor 293 is an elegant and highly functional panic bolt for single and double door applications. Incorporated as standard is an automatic top trip and easy clean floor socket. The main body is fitted with an anti-thrust device, which prevents leverage of both the top and bottom shoot bolts from their sockets.

Classification No.	3	7	6	B	1	3	4	2	B	A
EN 179 : 2008										

- Non-handed
- Fire rated for use on timber and steel doors
- Surface mounted

307 Push pad single panic bolt with horizontal pullman latches

The Exidor 307 offers all the elegance and functions of an Exidor push pad single panic bolt with the added feature of horizontal pullman latches which increases security and offers a smooth latching action.

Classification No.	3	7	6	B	1	3	4	2	B	A
EN 179 : 2008										

- Non-handed
- Surface mounted

310 Push pad single panic bolt with vertical pullman latches

The Exidor 310 offers all the elegance and functions of an Exidor push pad single panic bolt with the added feature of vertical pullman latches which increases security and offers a smooth latching action.

Classification No.	3	7	6	B	1	3	4	2	B	A
EN 179 : 2008										

- Non-handed
- Fire rated for use on timber and steel doors
- Surface mounted



Standard sizes

Standard size panic bolts are suitable for single doors up to 2440mm high. Special sizes are available on request.

Additional options

Exidor reversible panic bolts can be supplied with:

- Adjustable shoots
- suffix 'A' after the product code - 293 only
- Steel door fixings
- suffix 'SD' after the product code

Optional accessories for all the single panic bolts

- 302EA outside access device with euro aperture - knob operated
- 302EC outside access device with euro cylinder - knob operated
- 3020A outside access device with oval aperture - knob operated
- 3020C outside access device with oval cylinder - knob operated
- 322EA outside access device with euro aperture - lever operated
- 322EC outside access device with euro cylinder - lever operated
- 325EA outside access device with euro aperture - lever operated
- 325EC outside access device with euro cylinder - lever operated
- 326EA outside access device with euro aperture - knob operated
- 326EC outside access device with euro cylinder - knob operated
- 299 dogging device

Horizontal pullman latches



Vertical pullman latches

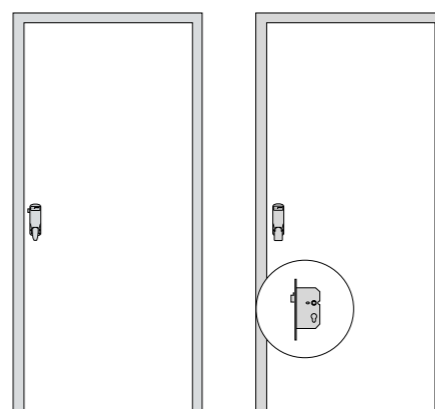
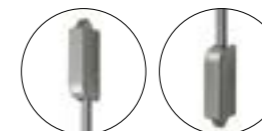

297

306

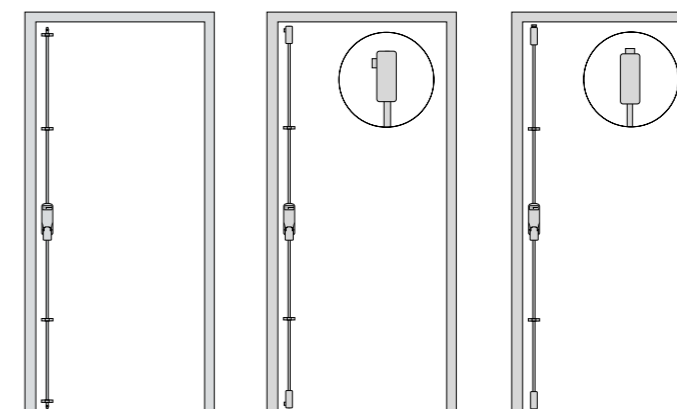

293 / 293A

307

310



Single doors 296 / 305

Single point locking

296 Reversible panic latch

The Exidor 296 is designed for single and double door applications. The unit is operated by a downward thrust of the cross bar to give a speedy exit in panic situations. An adapter for use with a rim cylinder for outside access is supplied as standard.

Classification No.	3	7	6	B	1	3	2	2	A	A
EN 1125 : 2008										

- Non-handed
- Fire rated for use on timber and steel doors
- Surface mounted
- Adapter for operating with a rim cylinder
- Closed arm design

305 Panic mortice actuator with cylinder mortice night latch

The Exidor 305 offers a push bar actuator unit with a cylinder mortice night latch case that can be supplied with or without a euro profile cylinder for access from the outside. A mortice plate is supplied as standard. The unit provides security on the outside with ease of escape from the inside in panic situations.

Classification No.	3	7	6	0	1	3	2	2	A	A
EN 1125 : 2008										

- Non-handed
- Surface mounted
- Closed arm design



Standard sizes

Panic latches are suitable for single doors up to 1220mm wide. Special sizes are available on request.

Additional options

Exidor reversible panic latches can be supplied with:

- Steel door fixings suffix 'SD' after the product code
- Microswitch suffix 'MS' after the product code

Optional accessories for the 296 panic latch

- 302EA outside access device with euro aperture - knob operated
- 302EC outside access device with euro cylinder - knob operated
- 3020A outside access device with oval aperture - knob operated
- 3020C outside access device with oval cylinder - knob operated
- 322EA outside access device with euro aperture - lever operated
- 322EC outside access device with euro cylinder - lever operated
- 325EA outside access device with euro aperture - lever operated
- 325EC outside access device with euro cylinder - lever operated
- 326EA outside access device with euro aperture - knob operated
- 326EC outside access device with euro cylinder - knob operated
- CL1 mechanical push button outside access device
- CL2 mechanical push button outside access device with passage facility
- CL3 quick code mechanical push button outside access device

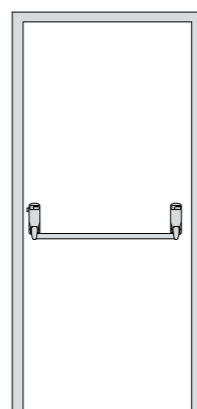

296

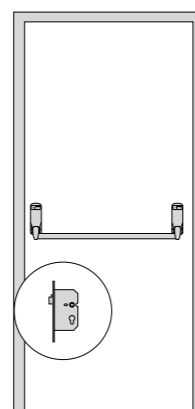

305



Single doors 294 / 308 / 311

Two point locking

294 Single panic bolt

The Exidor 294 is an elegant and highly functional panic bolt for single and double door applications. Incorporated as standard is an automatic top trip and easy clean floor socket. The main body is fitted with an anti-thrust device, which prevents leverage of both the top and bottom shoot bolts from their sockets.

Classification No.	3	7	6	B	1	3	2	2	A	A
EN 1125 : 2008										

- Non-handed
- Fire rated for use on timber and steel doors
- Surface mounted
- Closed arm design

308 Single panic bolt with horizontal pullman latches

The Exidor 308 offers all the elegance and functions of an Exidor single panic bolt with the added feature of horizontal pullman latches which increases the security and offers a smooth latching action.

Classification No.	3	7	6	B	1	3	2	2	A	A
EN 1125 : 2008										

- Non-handed
- Surface mounted
- Closed arm design

311 Single panic bolt with vertical pullman latches

The Exidor 311 offers all the elegance and functions of an Exidor single panic bolt with the added feature of vertical pullman latches which increases the security and offers a smooth latching action.

Classification No.	3	7	6	B	1	3	2	2	A	A
EN 1125 : 2008										

- Non-handed
- Fire rated for use on timber and steel doors
- Surface mounted
- Closed arm design



Standard sizes

Standard size panic bolts are suitable for single doors up to 1220mm wide and 2440mm high. Special sizes are available on request.

Additional options

Exidor reversible panic bolts can be supplied with:

- Adjustable shoots suffix 'A' after the product code - 294 only
- Steel door fixings suffix 'SD' after the product code
- Microswitch suffix 'MS' after the product code

Optional accessories for all the single panic bolts

- 302EA outside access device with euro aperture - knob operated
- 302EC outside access device with euro cylinder - knob operated
- 3020A outside access device with oval aperture - knob operated
- 3020C outside access device with oval cylinder - knob operated
- 322EA outside access device with euro aperture - lever operated
- 322EC outside access device with euro cylinder - lever operated
- 325EA outside access device with euro aperture - lever operated
- 325EC outside access device with euro cylinder - lever operated
- 326EA outside access device with euro aperture - knob operated
- 326EC outside access device with euro cylinder - knob operated
- 299 dogging device

Horizontal pullman latches

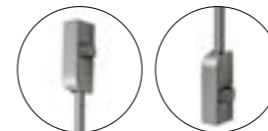

Vertical pullman latches

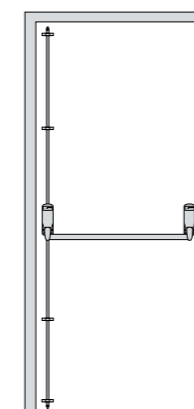
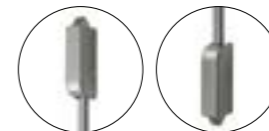

294 / 294A

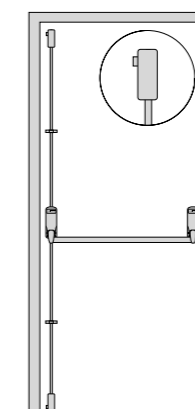

308

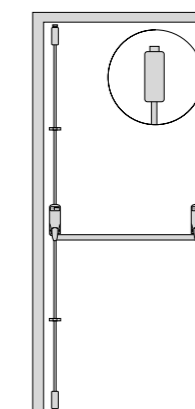

311



Double doors rebated 285 / 309 / 317

Three and four point locking

285 Double door set for rebated double doors

The Exidor 285 for rebated double doors is a complete package consisting of a panic latch (296), a panic bolt (294) and a box keep (300).

Classification No.	3	7	6	B	1	3	2	2	A	A
EN 1125 : 2008										

- Non-handed
- Fire rated for use on timber and steel doors
- Surface mounted
- Closed arm design

309 Double door set for rebated double doors

The Exidor 309 for rebated double doors is a complete package consisting of a panic bolt with horizontal pullman latches (308), another panic bolt with vertical pullman latches (311) and two horizontal pullman keeps (407).

Classification No.	3	7	6	B	1	3	2	2	A	A
EN 1125 : 2008										

- Non-handed
- Surface mounted
- Closed arm design

317 Double door set for rebated double doors

The Exidor 317 for rebated double doors consisting of a panic latch (296), a panic bolt with vertical pullman latches (311) and a box keep (300).

Classification No.	3	7	6	B	1	3	2	2	A	A
EN 1125 : 2008										

- Non-handed
- Fire rated for use on timber and steel doors
- Surface mounted
- Closed arm design

Horizontal pullman latches

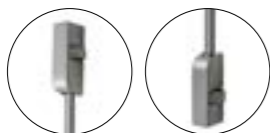

Vertical pullman latches

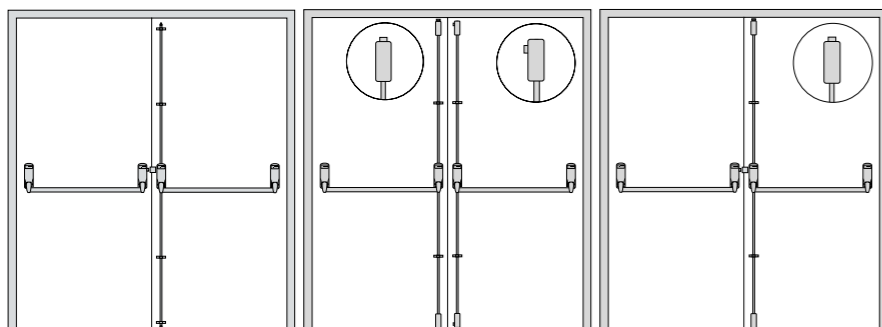
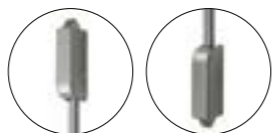

285

309

317



Standard sizes

Standard size panic bolts are suitable for single doors up to 1220mm wide and 2440mm high. Special sizes are available on request.

Additional options

Exidor reversible panic bolts can be supplied with:

- Adjustable shoots suffix 'A' after the product code - 293 only
- Steel door fixings suffix 'SD' after the product code
- Microswitch suffix 'MS' after the product code

Optional accessories for all rebated double door sets

- 302EA outside access device with euro aperture - knob operated
- 302EC outside access device with euro cylinder - knob operated
- 3020A outside access device with oval aperture - knob operated
- 3020C outside access device with oval cylinder - knob operated
- 322EA outside access device with euro aperture - lever operated
- 322EC outside access device with euro cylinder - lever operated
- 325EA outside access device with euro aperture - lever operated
- 325EC outside access device with euro cylinder - lever operated
- 326EA outside access device with euro aperture - knob operated
- 326EC outside access device with euro cylinder - knob operated
- 299 dogging device

Optional accessories for the 285 and 317 rebated double door sets

- CL1 mechanical push button outside access device
- CL2 mechanical push button outside access device with passage facility
- CL3 quick code mechanical push button outside access device



Double doors non-rebated 284 / 316

Four point locking

284 Double door set for non-rebated double doors

The Exidor 284 for non-rebated double doors is a complete package consisting of two single panic bolts (294).

Classification No.	3	7	6	B	1	3	2	2	A	A
EN 179 : 2008										

- Non-handed
- Fire rated for use on timber and steel doors
- Surface mounted
- Closed arm design

316 Double door set for non-rebated double doors

The Exidor 316 for non-rebated double doors is a complete package consisting of two panic bolts with vertical pullman latches (311).

Classification No.	3	7	6	B	1	3	2	2	A	A
EN 179 : 2008										

- Non-handed
- Fire rated for use on timber and steel doors
- Surface mounted
- Closed arm design

Vertical pullman latches

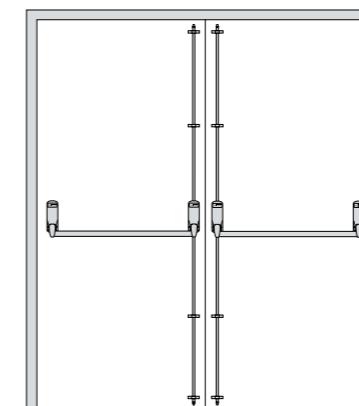
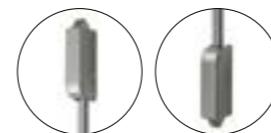

284

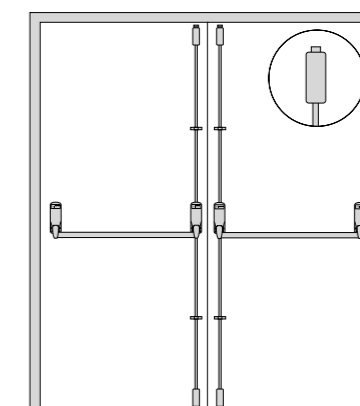

316



Standard sizes

Standard size panic bolts are suitable for single doors up to 1220mm wide and 2440mm high. Special sizes are available on request.

Additional options

Exidor reversible panic bolts can be supplied with:

- Adjustable shoots suffix 'A' after the product code - 284 only
- Steel door fixings suffix 'SD' after the product code
- Microswitch suffix 'MS' after the product code

Optional accessories for all non-rebated double door sets

- 302EA outside access device with euro aperture - knob operated
- 302EC outside access device with euro cylinder - knob operated
- 3020A outside access device with oval aperture - knob operated
- 3020C outside access device with oval cylinder - knob operated
- 322EA outside access device with euro aperture - lever operated
- 322EC outside access device with euro cylinder - lever operated
- 325EA outside access device with euro aperture - lever operated
- 325EC outside access device with euro cylinder - lever operated
- 326EA outside access device with euro aperture - knob operated
- 326EC outside access device with euro cylinder - knob operated
- 299 dogging device

CE MADE IN BRITAIN certifiere

Outside access devices

All Exidor 200/300 series OAD's have been certified for use with the Exidor 200/300 series range of bolts and latches. The use of any other OAD will invalidate the CE marking.

302 Knob operated outside access device

The Exidor 302 is supplied with 3 keys and has the advantage that a master keyed 40mm oval or euro profile cylinder can be used.

- Non-handed
- Fire rated for use on timber and steel doors
- Surface mounted on the outside of the door using concealed machine screws
- Supplied as standard for doors up to 45mm thick
- Longer spindles and screws are available on request for door thicknesses over 45mm

Performance

When locked, the mechanism is disengaged allowing the knob to freely rotate. When unlocked, the knob, spindle and mechanism engage allowing the shoots or latches of the panic bolt, or the panic latch, to be withdrawn from the outside. The knob remains engaged until it is re-locked.

Finishes

Available as standard in silver, there is also a choice of RAL colours and plated finishes. (See page 4).

Note: plated finishes are not generally recommended on outside access devices, unless being used on an internal route.

322 Lever operated outside access device

The Exidor 322 offers a lever operated outside access device that meets the dimensional requirements of BS8300 and approved document "M" (DDA). The 322 is supplied with 3 keys and has the advantage that a master keyed 45mm euro profile cylinder can be used.

- Non-handed.
- Meets the dimensional requirements of BS8300 and approved document "M" (DDA)
- Lever is supplied with special shear screw designed to break under excessive force
- Surface mounted on the outside of the door using concealed machine screws
- Same fixing points as the 302 OAD - easy retro fit
- Supplied as standard for doors up to 55mm thick
- Longer spindles and screws are available on request for door thicknesses over 55mm and 70mm

Performance

When locked, the lever is fixed in the horizontal position and the shear screw is designed to break under excessive force to prevent unauthorised entry. When unlocked, the lever, spindle and mechanism engage allowing the shoots, latch or pullman latches to be withdrawn from the outside. The lever remains engaged until the mechanism is re-locked.

Finishes

Available as standard in silver, there is also a choice of RAL colours and plated finishes.



302

Options available

- 302EC OAD with euro cylinder
- 302EA OAD with euro profile aperture
- 3020C OAD with oval cylinder
- 3020A OAD with oval profile aperture
- 302KA OAD with kaba profile aperture
- 302EC/RK OAD with key retention supplied with euro cylinder
- 302EA/RK OAD with key retention with euro profile aperture



322

Options available

- 322EC OAD with euro cylinder
- 322EA OAD with euro profile aperture

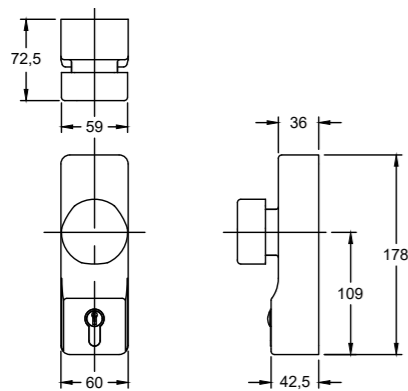

302

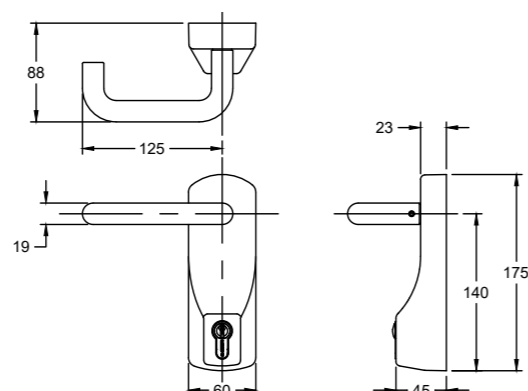

322

CE MADE IN BRITAIN certifiere

325 Lever operated outside access device

The Exidor 325 is an elegant lever operated outside access device that meets the dimensional requirements of equality act 2010 and BS8300 - approved document 'M'.

The OADs can be supplied with or without a 45mm single euro profile cylinder allowing flexibility where master keying is required.

Built to the same profile as the 326 knob OAD the lever and knob are interchangeable.

- Non-handed
- Lever meets the dimensional requirements of BS8300
- Cylinder version supplied with 3 keys
- Powder coated for durability
- Fixings to suit steel, timber, aluminium or uPVC doors
- For doors up to 65mm thick (longer fixings available)
- Key retention and keyed alike models also available

Performance

When locked the lever or knob is disengaged from the mechanism and still rotates therefore preventing unauthorised entry and damage to the unit. When unlocked the operator, spindle and mechanism engage, allowing the internal hardware's locking point(s) to be withdrawn from the outside of the door. The lever or knob remains engaged until the mechanism is re-locked.

Finishes

Available as standard in silver, there is also a choice of RAL colours and plated finishes.

Note: plated finishes are not generally recommended on outside access devices, unless being used on an internal route.

326 Knob operated outside access device

The Exidor 326 is a stylish knob operated outside access device that can be supplied with or without a 45mm single euro profile cylinder allowing flexibility where master keying is required.

Built to the same profile as the 325 lever OAD the knob and lever are interchangeable.

- Non-handed
- Cylinder version supplied with 3 keys
- Powder coated for durability
- Fixings to suit steel, timber, aluminium or uPVC doors
- For doors up to 65mm thick
- Key retention and keyed alike models also available



325

Options available

- 325EC OAD with euro cylinder
- 325EA OAD with euro profile aperture
- Suffix code with '/RK' for key retention model
- Suffix code with '/KA' for keyed alike option



326

Options available

- 326EC OAD with euro cylinder
- 326EA OAD with euro profile aperture
- Suffix code with '/RK' for key retention model
- Suffix code with '/KA' for keyed alike option

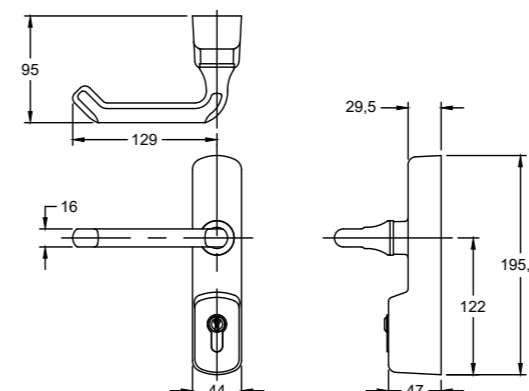

325

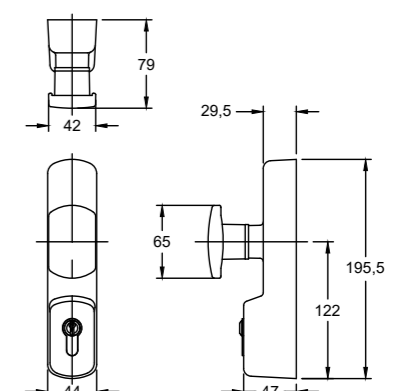

326



Mechanical push button outside access devices

CL1	Push button mechanical code lock
CL2	Push button mechanical code lock with passage function
CL3	Quick code mechanical code lock (code can be changed without removing the unit)

Only suitable for use with the Exidor 296 and 297 products.

The CL range of mechanical push button outside access devices offer a simple solution where access control is required to operate the 296 and 297 panic and emergency hardware.

There are two options within the range, the standard CL1/CL2 and the quick code CL3. The quick code option allows the mechanical code to be changed swiftly, without having to remove the unit from the door. Each version is available as a standard product, or with the passage function which allows the unit to be set in the code free mode allowing the handle to be opened without entering a code. Finished in PVD stainless steel or PVD brass, the CL range is suitable for high usage exterior applications, including corrosive environments, and all are supplied with three spindles, ensuring complete compatibility with the Exidor 296 and 297 products.

- 1,584 different codes available
- Non handed
- Reversible safety lever
- Surface mounted using concealed screws
- Clutch protection on the outside lever
- Supplied with spindles for doors from 35mm to 60mm thick
- PVD weather resistant finish
- Available in stainless steel or brass finishes

Performance

Once the correct code has been entered, the handle is released allowing the operation of the panic and emergency hardware from the outside of the door. When the handle returns to the horizontal position, it re-locks and the code needs to be entered again if access is required.

If the unit is set in passage mode, no code is required to operate the handle.

Finishes

PVD stainless steel or PVD brass.



CL1/CL2



CL3

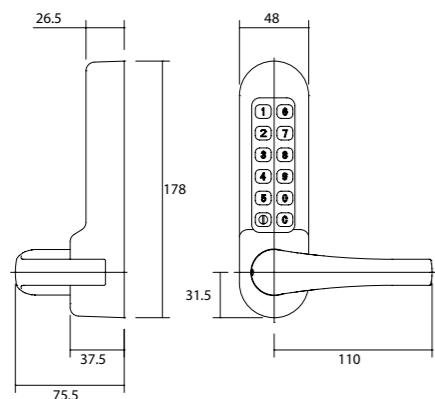

CL1/CL2

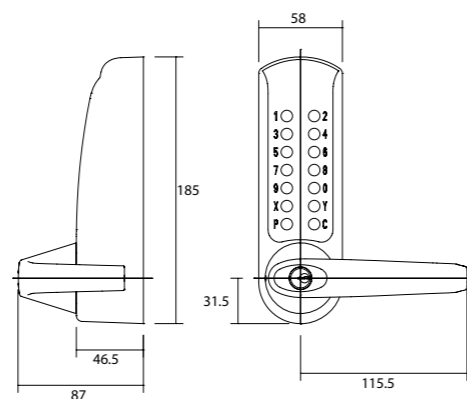

CL3



Add-on accessories

Dogging devices and latch kits

299	Dogging device
------------	----------------

For use with the Exidor panic bolt and pullman latch ranges. The dogging device allows the bolts to be withheld in the retracted position ensuring the automatic top trip catch or pullman latch do not engage when the door is closed.

314	Vertical pullman latch kit
315	Horizontal pullman latch kit

The Exidor pullman latch kits can be supplied for any of the Exidor panic bolt range to upgrade a unit, and are suitable for doors that are subject to a high volume of traffic, or when a higher level of security is required.

The pullman latches are available in both vertical and horizontal versions and provide a smooth and quiet alternative to the traditional top trip catch. They are recommended for interconnecting doors as well as external doors. The level of security is increased as the latches operate independently and yet they maintain the emergency facility in that they are retracted in one action by the cross bar, push pad or touch bar when required. The pullman latches are housed in an enclosed keep and are designed so that they can only be attacked by going through the door. However, due to the design, the latch will throw outwards rather than retract if attacked, thus increasing security.

Accessories for non-standard doors

For doors that exceed the size of 1220mm wide and 2440mm high, the following top shoots and oval push bar tubes are available:

Top shoot tube

P0801	1210mm top shoot tube for doors up to 2440mm high
P0802	1600mm top shoot tube for doors up to 2680mm high
P0803	2100mm top shoot tube for doors up to 3180mm high

Oval push bar tube

P1001	1180mm oval push bar tube for panic bolts up to 1220mm wide
P1002	1600mm oval push bar tube for panic bolts up to 1650mm wide
P1003	2100mm oval push bar tube for panic bolts up to 2150mm wide

Mortice actuator accessories

P3054	Euro profile cylinder for cylinder mortice night latch
P1803	Key blank for euro profile cylinder
RK13	13mm rebate set for cylinder mortice night latch
RK25	25mm rebate set for cylinder mortice night latch

* Please note that rebate kits are handed.



299



314



315



Timber door keeps

Latch bolt keeps

P1601 Standard latch keep

- 200 Series latch keep
- Supplied as standard with the 296 and 297 panic latches

Construction: mild steel
Finish: electro galvanised / plated finish not available

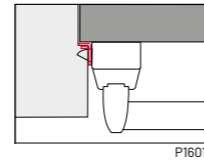

ED150 Latch keep

- 200 Series latch keep for timber and steel frames
- Surface mounted
- No clearance hole to accept latch is required

Construction: diecast zinc
Finish: powder coated / RAL available on request / plated finish not available

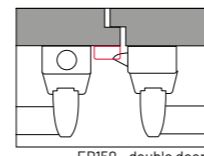
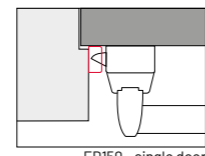
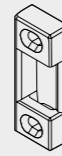

300 Double rebated door keep

- Used for rebated double doors for the Exidor 296 push bar panic latch and 297 push pad panic latch.

Construction: mild steel
Finish: powder coated / RAL available on request / plated finish available

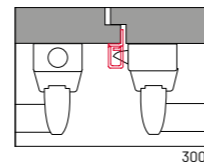
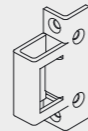

Top bolt keeps

P0401 Top trip

- Used for standard bolts on timber frames
- Supplied as standard with the 296 and 297 panic latches

Construction: mild steel
Finish: electro galvanised / RAL available on request / plated finish not available

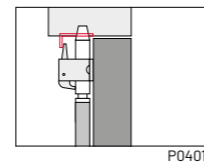
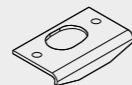

2405 Top trip

- Surface mounted keep for top shoot bolts on timber and steel frames
- For flush fitting doors / frames
- Used with 200 series panic bolts

Construction: mild steel
Finish: electro galvanised / RAL available on request / plated finish not available

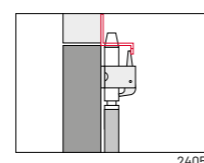
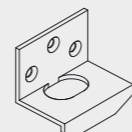

3405A Top trip

- Surface mounted keep for timber top header rail
- No clearance hole in the header rail to accept the top shoot bolt is required

Construction: diecast zinc / mild steel
Finish: electro galvanised / plated finish not available

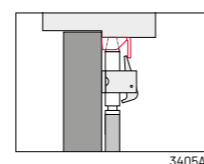
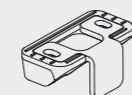

2401 Top trip

- Surface mounted keep for top shoot bolts
- Kit supplied includes spacers for applications where the distance between the header rail and the door face is between 14mm and 21mm

Construction: mild steel
Finish: electro galvanised / RAL available on request / plated finish not available

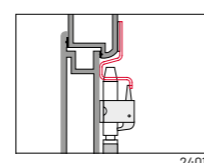
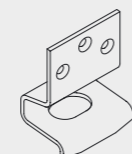

Bottom bolt keeps

P1301 Standard bottom keep

- Standard 200 series bottom bolt keep
- Supplied as standard with the 293, 294, 284 and 285 panic and emergency exit bolts

Construction: mild steel
Finish: electro galvanised

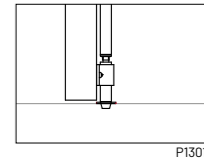
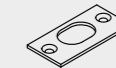

2403 Low threshold bottom keep

- For low thresholds or an alternative to boring a hole in a concrete floor to accept the bottom shoot bolt
- Designed to the requirements of CEN standards and building regulations

Construction: mild steel
Finish: electro galvanised / RAL available on request / plated finish not available

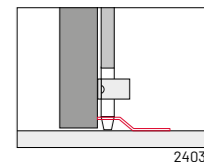
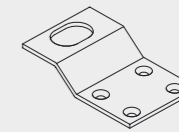

3405 Bottom keep

- Surface mounted keep for bottom shoot bolts
- No clearance hole in the floor is required

Construction: diecast zinc
Finish: electro galvanised / plated finish not available

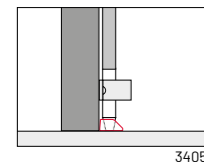
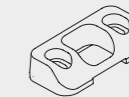

Pullman latch keeps

3401 Vertical pullman latch keep

- For 300 series vertical pullman latches on flush fitting doors / frames

Construction: mild steel
Finish: electro galvanised / RAL available on request / plated finish not available

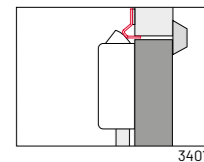
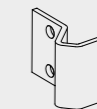

3402 Vertical pullman latch keep

- For 300 series vertical pullman latches
- Supplied as standard with all pullman latch units

Construction: diecast aluminium
Finish: powder coated black / plated finish not available

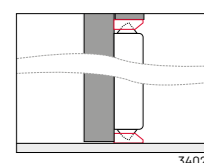
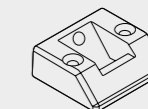

407 Horizontal pullman latch keep

- Used with Exidor horizontal pullman latches for both flush fitting doors/ frames and on double rebated door applications
- Supplied as standard with the 307 and 308 panic bolt

Construction: mild steel
Finish: electro galvanised / RAL available on request / plated finish available

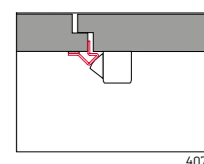
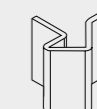



Steel door keeps

Latch bolt keeps

ED150 Latch keep

- 200 Series latch keep for timber and steel frames
- Surface mounted
- No clearance hole to accept latch is required

Construction: diecast zinc
Finish: powder coated / RAL available on request / plated finish not available

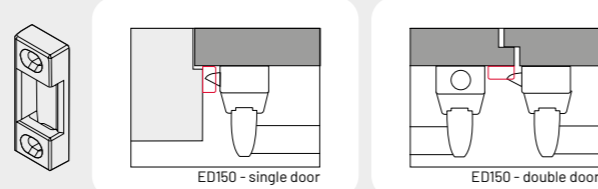

3404 Latch keep

- 200 Series latch keep for steel frames

Construction: mild steel
Finish: electro galvanised / plated finish not available

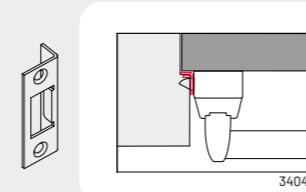

300 Double rebated door keep

- Used for rebated double doors for the Exidor 296 push bar panic latch and 297 push pad panic latch.

Construction: mild steel
Finish: powder coated / RAL available on request / plated finish available

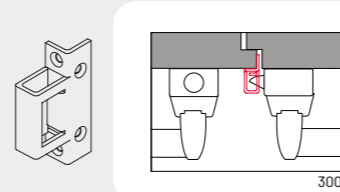

Top bolt keeps

2405 Top trip

- Surface mounted keep for top shoot bolts on timber and steel frames
- For flush fitting doors / frames
- Used with 200 series panic bolts

Construction: mild steel
Finish: electro galvanised / RAL available on request / plated finish not available

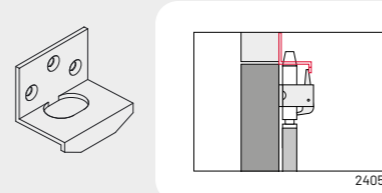

3405A/SD Keep

- Surface mounted keep for steel top header rail
- No clearance hole in the header rail to accept the top shoot bolt is required

Construction: diecast zinc / mild steel
Finish: electro galvanised / plated finish not available

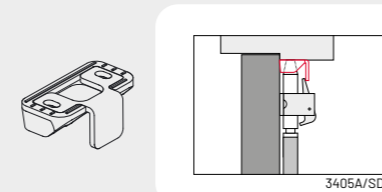

Bottom bolt keeps

P1301 Standard bottom keep

- Standard 200 series bottom bolt keep
- Supplied as standard with the 293, 294, 284 and 285 panic and emergency exit bolts

Construction: mild steel
Finish: electro galvanised

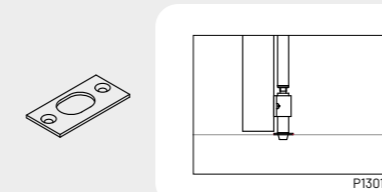

2403 Low threshold bottom keep

- For low thresholds or an alternative to boring a hole in a concrete floor to accept the bottom shoot bolt
- Designed to the requirements of CEN standards and building regulations

Construction: mild steel
Finish: electro galvanised / RAL available on request / plated finish not available

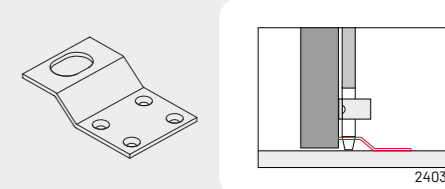

3405 Bottom keep

- Surface mounted keep for bottom shoot bolts
- No clearance hole in the floor is required

Construction: diecast zinc
Finish: electro galvanised / plated finish not available

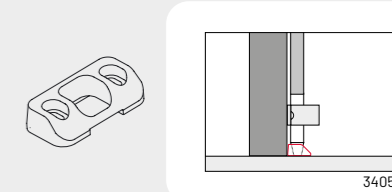

Pullman latch keeps

3401 Vertical pullman latch keep

- For 300 series vertical pullman latches on flush fitting doors / frames

Construction: mild steel
Finish: electro galvanised / RAL available on request / plated finish not available

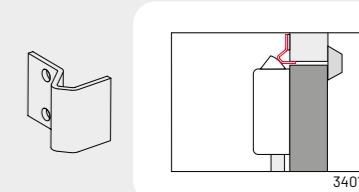

3402 Vertical pullman latch keep

- For 300 series vertical pullman latches
- Supplied as standard with all pullman latch units

Construction: diecast aluminium
Finish: powder coated black / plated finish not available

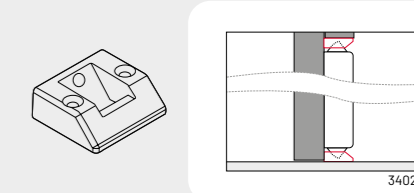

407 Horizontal pullman latch keep

- Used with Exidor horizontal pullman latches for both flush fitting doors/ frames and on double rebated door applications
- Supplied as standard with the 307 and 308 panic bolt

Construction: mild steel
Finish: electro galvanised / RAL available on request / plated finish available

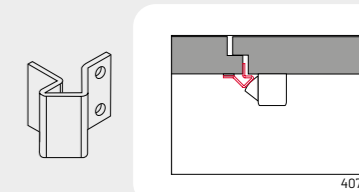

CE MADE IN BRITAIN certifire

uPVC door keeps

Bottom bolt keeps

2401 Top trip

- Surface mounted keep for top shoot bolts
- Kit supplied includes spacers for applications where the distance between the header rail and the door face is between 14mm and 21mm

Construction: mild steel
Finish: electro galvanised / RAL available on request / plated finish not available

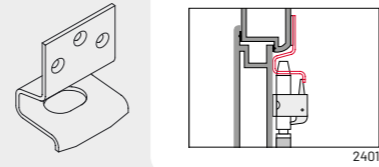

P1301 Standard bottom keep

- Standard 200 series bottom bolt keep
- Supplied as standard with the 293, 294, 284 and 285 panic and emergency exit bolts

Construction: mild steel
Finish: electro galvanised

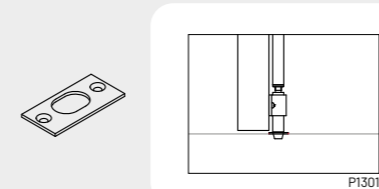

2403 Low threshold bottom keep

- For low thresholds or an alternative to boring a hole in a concrete floor to accept the bottom shoot bolt
- Designed to the requirements of CEN standards and building regulations

Construction: mild steel
Finish: electro galvanised / RAL available on request / plated finish not available

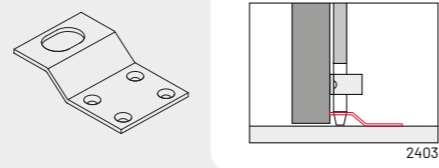

3405 Bottom keep

- Surface mounted keep for bottom shoot bolts
- No clearance hole in the floor is required

Construction: diecast zinc
Finish: electro galvanised / plated finish not available

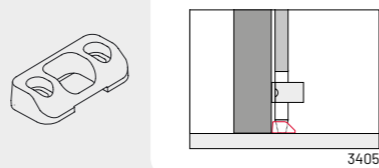

2402 Bottom keep

- For UPVC doors / frames that have a high threshold
- Complete with spacers for applications where the distance between the door face and face of the threshold is between 14mm and 21mm

Construction: mild steel
Finish: electro galvanised / RAL available on request / plated finish not available

Note:
This accessory is not CE marked
and cannot be used on escape
doors within the EU

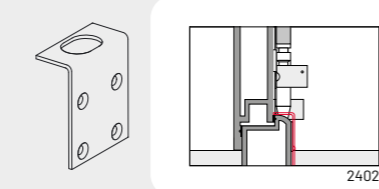

Pullman latch keeps

3401 Vertical pullman latch keep

- For 300 series vertical pullman latches on flush fitting doors / frames

Construction: mild steel
Finish: electro galvanised / RAL available on request / plated finish not available

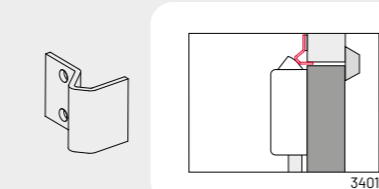

3402 Vertical pullman latch keep

- For 300 series vertical pullman latches
- Supplied as standard with all pullman latch units

Construction: diecast aluminium
Finish: powder coated black / plated finish not available

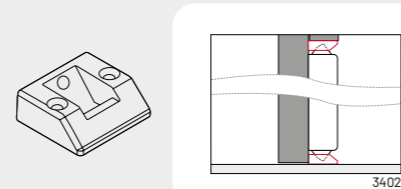

CE MADE IN BRITAIN certifire

407 Horizontal pullman latch keep

- Used with Exidor horizontal pullman latches for both flush fitting doors / frames and on double rebated door applications
- Supplied as standard with the 307 and 308 panic bolt

Construction: mild steel
Finish: electro galvanised / RAL available on request / plated finish available

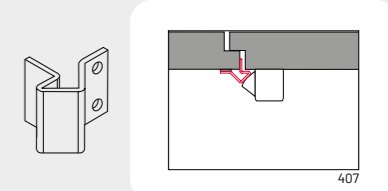

3403 Keep

- Used for 300 series horizontal latches on UPVC double doors
- Optional longer version available (SL-0156)

Construction: mild steel
Finish: electro galvanised / RAL available on request / plated finish not available

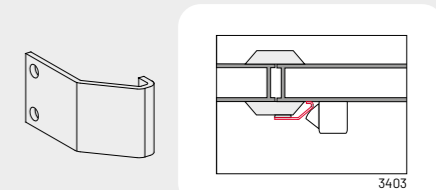

Maintenance

It is important that all panic and emergency exit hardware devices are inspected and maintained properly to ensure safety is maintained when exiting a building in any situation.

Once the device is fitted regular maintenance is recommended.

Weekly:

- Make sure the exit device functions correctly
- Any fixings that have worked loose should be re-secured
- Any damaged components should be replaced
- Ensure there are no obstructions which prevent the panic/emergency exit unit from functioning correctly

Every three months:

- Check for wear. Any visible worn components should be replaced

Fixing/installation

Installation instructions are supplied with all the Exidor panic and emergency exit hardware. Provided the instructions are followed and the units are fitted by a competent person, the Exidor range will offer a high degree of safety and security. No responsibility can be accepted by the manufacturer if the installation instructions are not followed.

In order to meet the CEN European standards the door and frame should be of good quality and suitable to support the hardware.

All bars and shoots should be cut to the exact size on site and each shoot is supplied with loose end plugs.

Unless specified all the Exidor range is supplied with all the necessary fixings for timber frames and doors. However, for alternative fixings for steel doors please contact the manufacturer or your supplier.

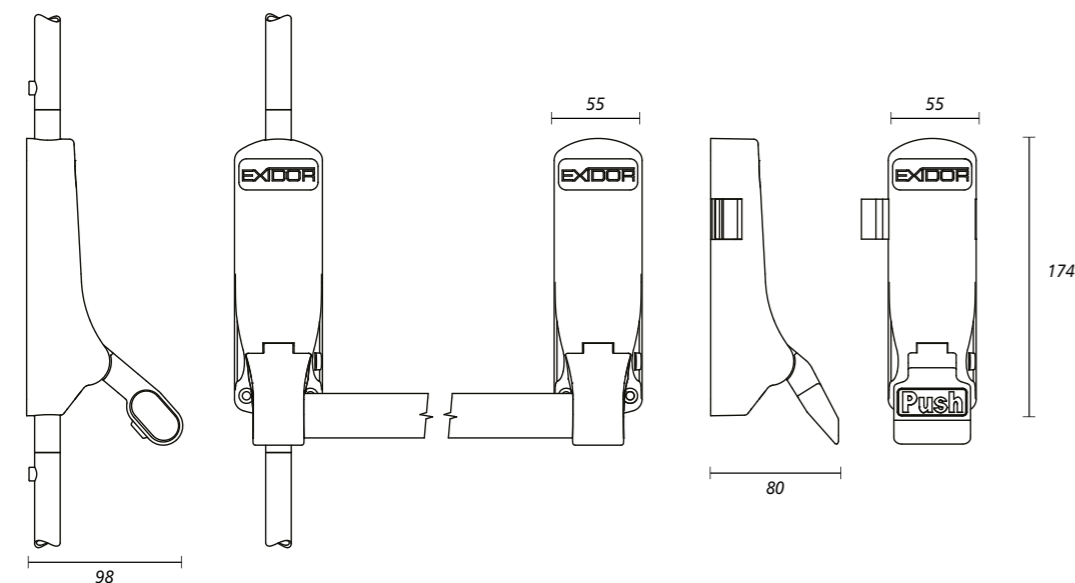

Push bar three point panic bolt

Construction

The main body and passive units are constructed of die cast aluminium with extruded aluminium guides. The internal components and shoot ends are of solid steel with tubular steel shoots, and the latch bolts are in extruded brass.

Passivate protection – on request

The passivation process gives extra protection to the steel components and is recommended when the product is to be used in harsh conditions, such as outside gates, around swimming pools or coastal areas.

Chromating - on request

Chromating offers increased protection to the aluminium components in harsh condition such as outside gates, around swimming pools or coastal areas.

Standard sizes

Standard sized units are suitable for doors up to 1220mm wide and 2440mm high. The shoot bolts and cross bars can be cut down on site to suit the door height and width.

For larger doors above 2440mm high special size top shoot bolt lengths are available upon request. The following lengths are stocked by Exidor.

- 1210mm for doors up to 2440mm high (Standard size supplied)
- 1600mm for doors up to 2680mm high
- 2100mm for doors up to 3180mm high

Fire rating

The Exidor 200/300 series is approved by certifiere for use on timber and steel doors to EN 1634-1 : 2000. The rating will depend on the certification of the fire door. It is important to realise that the hardware is required for the first part of the test until the door is sealed into the frame. After this period of time the fire door is then responsible for sealing off the area.

Push pad emergency exit latch

1	Panic push bar
2	Top shoot tube
3	Bottom shoot tube
4	Guide
5	Top trip assembly
6	Bottom guide
7	Bottom keep plate
8	Panic bolt body assembly
9	Passive unit
10	Push pad panic latch assembly
11	Push bar end plugs
12	Top shoot bolt
13	Bottom shoot bolt
14	Push pad label
15	Foil label
16	Vertical pullman latch
17	Horizontal pullman latch
18	Latch keep
19	Top trip plate
20	Tube screws
21	Pullman latch keep

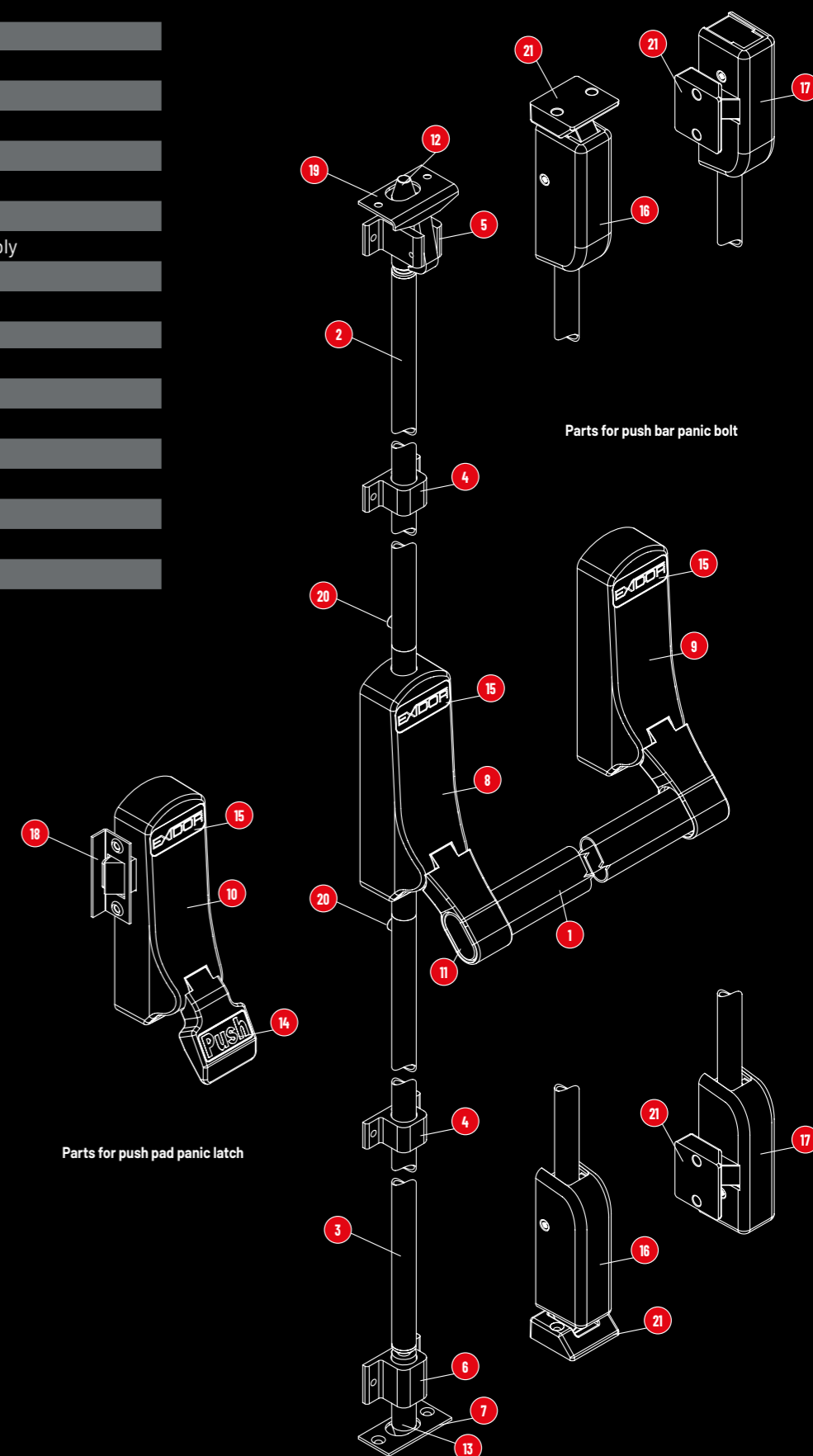

Parts for push bar panic bolt

Parts for push pad panic latch

The two standards for panic and emergency exit hardware are as follows:-

EN1125: 2008

For push bar and touch bar devices which can be used in any environment, particularly areas open to members of the public.

Application examples: shopping centres, areas of entertainment, public buildings



EN179: 2008

For push pad and lever handle devices which can only be used in areas where occupants of the building are familiar with the layout and means of escape, and where members of the public do not have access.

Application examples: factory, warehouse, offices



Classification coding system for panic and emergency exit hardware

Under both these two standards each product is tested and classified accordingly to show its compliance by the identification of a 10-digit code that is visible on the product and fitting instructions. Each digit represents a category and how it measured against the standard to which it was tested.

Example:

Digit	1	2	3	4	5	6	7	8	9	10
Classification No.	3	7	6	B	1	3	2	2	A	A



Digit 1 – Category of use

Only one category is identified
 3 = high frequency of use where there is little incentive to exercise care, i.e. where there is a chance of an accident occurring and misuse.
Example: Doors to shops, hospitals, schools and other buildings which provide access to designated areas and which are used by the public and others frequently carrying or propelling bulky objects

Digit 2 – Durability

6 = tested up to 100,000 cycles
 7 = tested up to 200,000 cycle

Digit 3 – Door mass

5 = for doors up to 100kg
 6 = for doors up to 200kg
 7 = for doors over 200kg

Digit 4 – Suitability for use on fire/smoke doors

0 = not approved for use on fire / smoke door assemblies
 A = suitable for use on smoke door assemblies
 B = Suitable for use on fire and smoke door assemblies based on a test in accordance with EN1634-1

Digit 5 – Safety

Only the top grade is allowed on panic and emergency exit hardware
 1 = safety

Digit 6 – Corrosion resistance to EN 1670

3 = high resistance
 4 = very high resistance

Digit 7 – Security for product

EN 1125
 2 = 1,000 N – this is the only grade allowed under EN 1125

 EN 179
 2 = 1,000N / 3 = 2,000N / 4 = 3,000N / 5 = 5,000N
 These four grades are used to allow the opportunity of greater security because these devices are subject to testing with doors under a greater pressure.

Digit 8 – Projection of device

1 = large projection (projection of 150mm from the face of the door)
 2 = standard projection (projection of 100mm from the face of the door)

Digit 9 – Type of device

EN 179
 A = emergency device using a lever handle
 B = emergency device using a push pad

 EN 1125
 A = panic device using a push bar
 B = panic device using a touch bar

Digit 10 – Door application

EN 179
 A = outwardly opening single exit door, double exit door: active or inactive leaf
 B = outwardly opening single exit door only
 C = outwardly opening double exit door: inactive leaf only
 D = inwardly opening single exit door only

EN 1125
 A = single door, double door: active or inactive leaf
 B = single door only
 C = double door, inactive leaf only

Emergency exit hardware

Products that are classified as emergency exit hardware offer a single operation of a lever or push pad to release the device. These are certified to EN 179 and can be used on premises that require prior knowledge of its operation and where panic situations are not foreseen, such as offices and areas that are not open to the public.

Panic exit hardware

Products that are classified as panic exit hardware offer a single operation of a push bar or touch bar to release the device. These are certified to EN 1125 and can be used on premises that do not require prior knowledge of its operation and where panic situations are foreseen, such as places of entertainment, public buildings and areas open to the public.

Rebated doors

A pair of double doors that are rebated.

Non-rebated doors

A pair of double doors that are flush fitting.

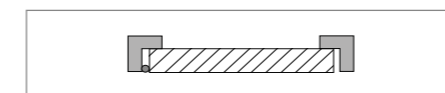

Single Door

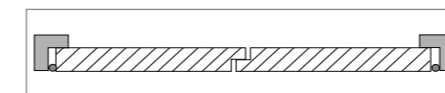

Rebated Doors

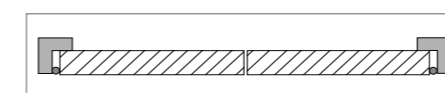

Non-Rebated Doors

Mechanism unit

This is the main unit that controls the travel of the bolts and latches.

Automatic top trip

Device used to hold the bolts in the withdrawn position when the door is open. When the door is closed too, the automatic top trip releases the bolts securing the door.

Anti-thrust

A device built into a unit to prevent either a bolt or latch from being forced back when in the closed position, thus increasing the level of security.

Adjustable shoots

To overcome the problem of bolts not fully engaging in the keeps due to the door or frame moving after a period of time, adjustable shoots are available on Exidor panic bolts. They allow ± 5mm of adjustment, and are particularly suited for soft wood, upvc and steel doors.

Actuator unit

The actuator unit connects the panic or emergency exit hardware to a mortice night latch. When used with a micro switch, the actuator unit can be connected to an electrical circuit to operate products such as an electro-magnetic lock.

Passive unit

The passive unit supports the cross bar on any panic hardware.

Microswitch

For situations that require the panic hardware to be linked to a monitoring or alarm system a micro switch can be fitted in the passive unit. The micro switch closes an electrical circuit when the cross bar is operated.

Single doors

Product No.	Description	EN Standard		Shoot bolts		Pullman latches		Micro switch	Steel door fixings	CE Mark	Fire rated	Locking points
		179	1125	Standard	Adjustable	Vertical	Horizontal					
293	Push pad single panic bolt	●		●						●	●	2
293SD	Push pad single panic bolt for steel doors	●		●					●	●	●	2
293A	Push pad single panic bolt with adjustable shoots	●			●					●	●	2
293A/SD	Push pad single panic bolt with adjustable shoots for steel doors	●			●				●	●	●	2
294	Push bar single panic bolt		●	●						●	●	2
294SD	Push bar single panic bolt for steel doors		●	●					●	●	●	2
294A	Push bar single panic bolt with adjustable shoots		●		●					●	●	2
294A/SD	Push bar single panic bolt with adjustable shoots for steel doors		●		●				●	●	●	2
294MS	Push bar single panic bolt with micro switch		●	●				●		●	●	2
294MS/SD	Push bar single panic bolt with micro switch for steel doors		●	●				●	●	●	●	2
294A/MS	Push bar single panic bolt with adjustable shoots and micro switch		●		●			●		●	●	2
294A/MS/SD	Push bar single panic bolt with adjustable shoots and micro switch for steel doors		●		●			●	●	●	●	2
296	Push bar panic latch		●							●	●	1
296SD	Push bar panic latch for steel doors		●						●	●	●	1
296MS	Push bar panic latch with micro switch		●					●		●	●	1
296MS/SD	Push bar panic latch with micro switch for steel doors		●					●	●	●	●	1
297	Push pad panic latch	●								●	●	1
297SD	Push pad panic latch for steel doors	●							●	●	●	1
301	Push bar mortice actuator only											1
301SD	Push bar mortice actuator only for steel doors								●			1
301MS	Push bar mortice actuator only with micro switch							●				1
303	Push pad mortice actuator only											1
303SD	Push pad mortice actuator only for steel doors								●			1
305	Push bar mortice actuator with night latch case		●							●		1
305SD	Push bar mortice actuator with night latch case for steel doors		●						●	●		1
305MS	Push bar mortice actuator with night latch case with micro switch		●					●		●		1
306	Push pad mortice actuator with night latch case	●								●		1
306SD	Push pad mortice actuator with night latch case for steel doors	●							●	●		1
307	Push pad single panic bolt with horizontal pullman latches	●					●			●		2
307SD	Push pad single panic bolt with horizontal pullman latches for steel doors	●					●		●	●		2
308	Push bar single panic bolt with horizontal pullman latches		●				●			●		2
308SD	Push bar single panic bolt with horizontal pullman latches for steel doors		●				●		●	●		2
310	Push pad single panic bolt with vertical pullman latches	●				●				●	●	2
310SD	Push pad single panic bolt with vertical pullman latches for steel doors	●				●			●	●	●	2
311	Push bar single panic bolt with vertical pullman latches		●			●				●	●	2
311SD	Push bar single panic bolt with vertical pullman latches for steel doors		●			●			●	●	●	2
311MS	Push bar single panic bolt with vertical pullman latches with micro switch		●			●		●		●	●	2
311MS/SD	Push bar single panic bolt with vertical pullman latches with micro switch for steel doors		●			●		●	●	●	●	2

Rebated double doors

Product No.	Description	EN standard		Shoot bolts		Pullman latches		Micro switch	Steel door fixings	CE Mark	Fire rated	Locking points
		179	1125	Standard	Adjustable	Vertical	Horizontal					
285	Double door set		●	●						●	●	3
285SD	Double door set for steel doors		●	●					●	●	●	3
285A	Double door set with adjustable shoots		●		●					●	●	3
285A/SD	Double door set with adjustable shoots for steel doors		●		●				●	●	●	3
285MS	Double door set with micro switches		●	●				●		●	●	3
285MS/SD	Double door set with micro switches for steel doors		●	●				●	●	●	●	3
285A/MS	Double door set with adjustable shoots and micro switch		●		●			●		●	●	3
285A/MS/SD	Double door set with adjustable shoots and micro switch for steel doors		●		●			●	●	●	●	3
309	Double door set with horizontal and vertical pullman latches		●			●	●			●		4
309SD	Double door set with horizontal and vertical		●			●	●		●	●		2
309MS	Double door set with micro switches and horizontal and vertical pullman latches		●			●	●	●		●		4
309MS/SD	Double door set with micro switches and horizontal and vertical pullman latches for steel doors		●			●	●	●	●	●		4
317	Double door set with vertical Pullman latches and latch		●			●				●	●	3
317SD	Double door set with vertical pullman latches and latch for steel doors		●			●			●	●	●	3
317MS	Double door set with vertical pullman latches and latch with micro switches		●			●		●		●	●	3
317MS/SD	Double door set with vertical pullman latches and latch with micro switches for steel doors		●			●		●	●	●	●	3

Non-rebated double doors

Product No.	Description	EN standard		Shoot bolts		Pullman latches		Micro switch	Steel door fixings	CE Mark	Fire rated	Locking points
		179	1125	Standard	Adjustable	Vertical	Horizontal					
284	Double door set		●	●						●	●	4
284SD	Double door set for steel doors		●	●					●	●	●	4
284A	Double door set with adjustable shoots		●		●					●	●	4
284A/SD	Double door set with adjustable shoots for steel doors		●		●				●	●	●	4
284MS	Double door set with micro switches		●	●				●		●	●	4
284MS/SD	Double door set with micro switches for steel doors		●	●				●	●	●	●	4
284A/MS	Double door set with adjustable shoots and micro switches		●		●			●		●	●	4
284A/MS/SD	Double door set with adjustable shoots and micro switches for steel doors		●		●			●	●	●	●	4
316	Double door set with vertical Pullman latches		●			●				●	●	4
316MS	Double door set with micro switches with vertical Pullman latches		●			●		●		●	●	4
316MS/SD	Double door set with micro switches with vertical Pullman latches for steel doors		●			●		●	●	●	●	4



ASSA ABLOY

UN459 version 1

ASSA ABLOY Opening Solutions UK & Ireland, Door Hardware Group,
School Street, Willenhall, West Midlands WV13 3PW, UK

Tel: 0845 223 2124

Email: csdcomm@assaabloy.com

Web: uniononline.co.uk

Every effort has been made to ensure the accuracy of product information at time of publication in November 2021. We are continually developing our products and reserve the right to change the specification of the products within this catalogue with or without prior notice. Subject to our Terms and Conditions of trading, a copy of our T's and C's is available upon request.

For further help or information, please visit uniononline.co.uk or call our customer service team.



certifire

Performance you can trust